

NO: 94-2576  
0,725 Kg.m.

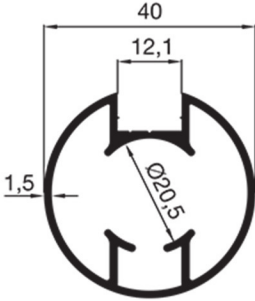

NO: 94-1786  
0,880 Kg.m.

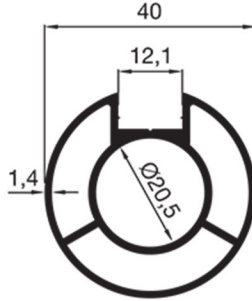

NO:94-2630  
0,690 Kg.m.

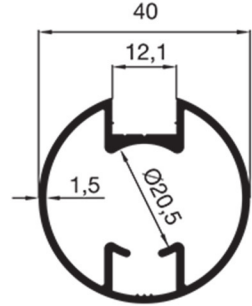

NO:94-2577  
0,700 Kg.m.

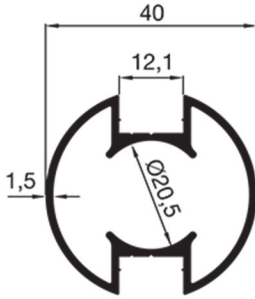

NO: 94-1787  
0,840 Kg.m.

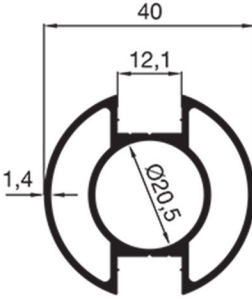

NO:94-2001  
0,670 Kg.m.

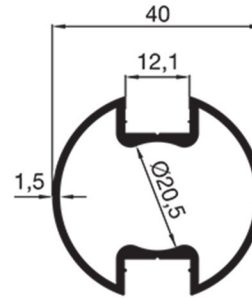

NO:94-2705  
0,855 Kg.m.

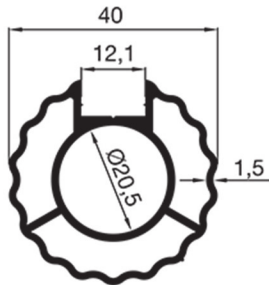

NO: 94-1788  
0,070 Kg.m.

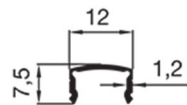

NO:94-1789  
0,880 Kg.m.

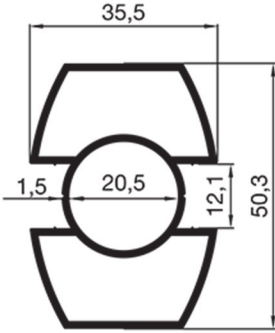

NO:94-2580  
0,580 Kg.m.

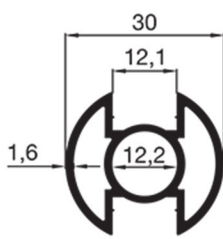

NO:94-2350  
0,875 Kg.m.

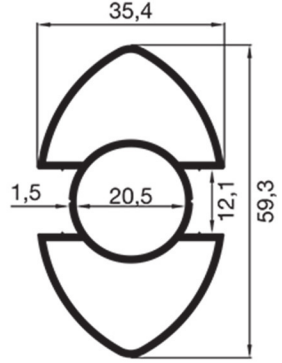

NO:94-2529  
0,435 Kg.m.

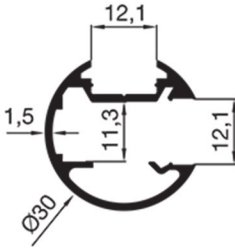

NO:94-1788  
0,070 Kg.m.

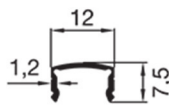

NO:94-2435  
0,405 Kg.m.

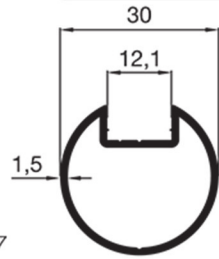

NO:94-2050  
1,425 Kg.m.

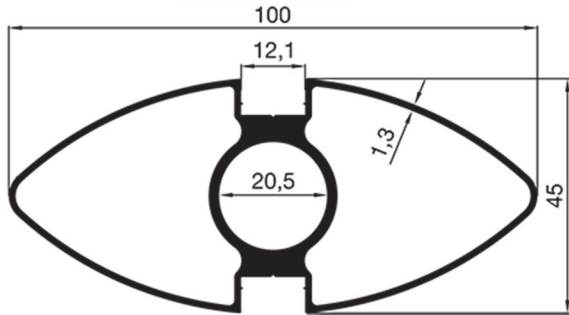

NO:94-2530  
0,130 Kg.m.

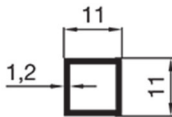

NO: 94-2089  
0,980 Kg.m.

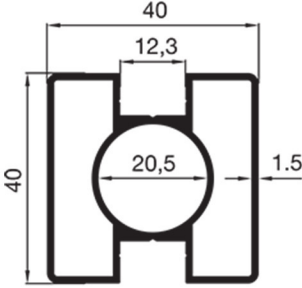

NO: 94-2678  
1,000 Kg.m.

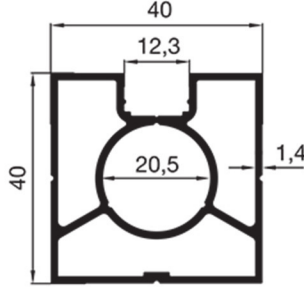

NO: 94-2825  
0,965 Kg.m.

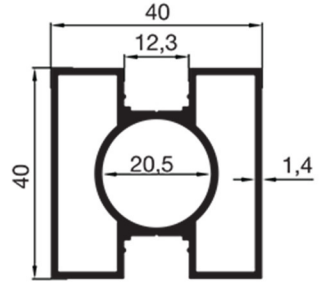

NO: 94-2091  
0,075 Kg.m.

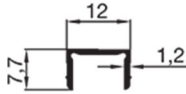

NO: 94-2679  
0,070 Kg.m.

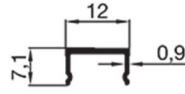

NO: 94-2579  
0,880 Kg.m.

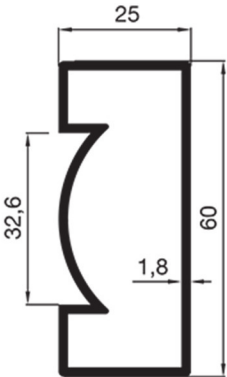

NO: 94-2729  
1,060 Kg.m.

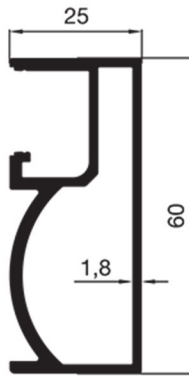

NO: 94-2716  
1,055 Kg.m.

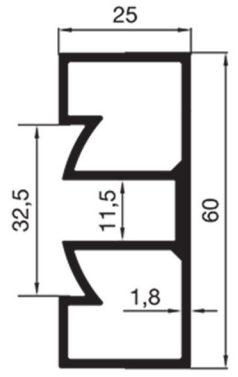

NO: 94-2672  
1,060 Kg.m.

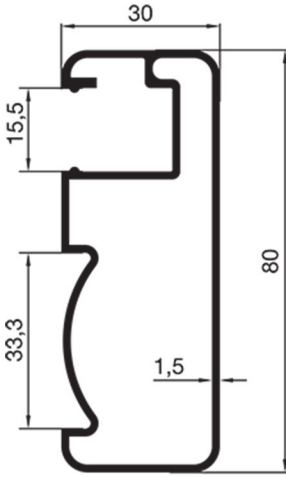

NO: 94-2770  
0,980 Kg.m.

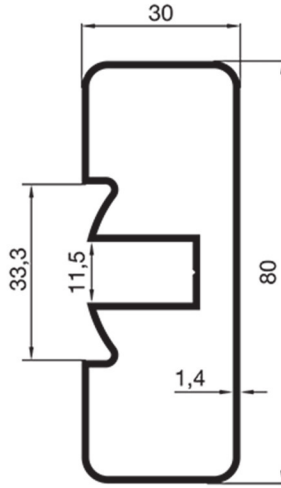

NO: 94-2578  
0,305 Kg.m.

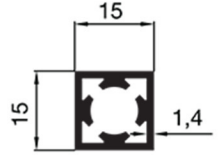

NO: 94-2811  
0,275 Kg.m.

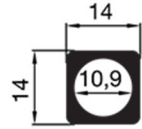

NO: 94-2746  
0,070 Kg.m.

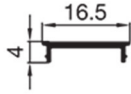

NO: 94-2679  
0,070 Kg.m.

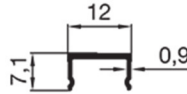

NO: 94-2745  
0,590 Kg.m.

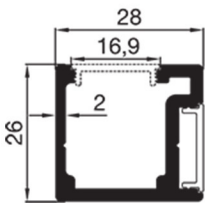

NO: 94-2790  
0,480 Kg.m.

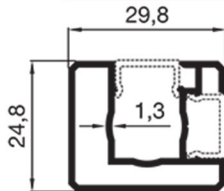

NO: 94-2829  
0,260 Kg.m.

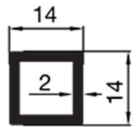

NO :94-2714  
0,460 Kg.m.

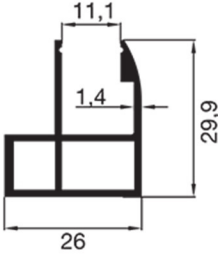

NO :94-2686  
0,435 Kg.m.

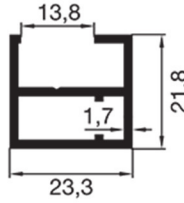

NO :94-2725  
0,270 Kg.m.

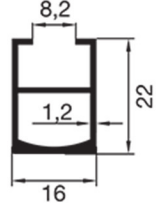

NO :94-2717  
0,765 Kg.m.

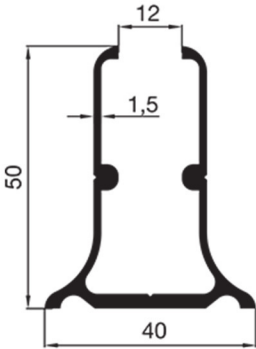

NO :94-2761  
1,445 Kg.m.

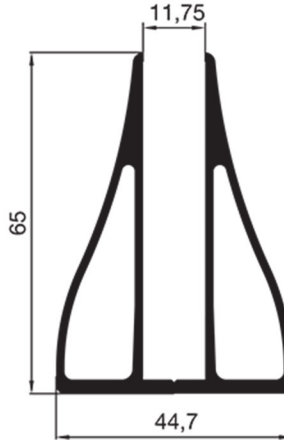

NO :94-2436  
1,500 Kg.m.

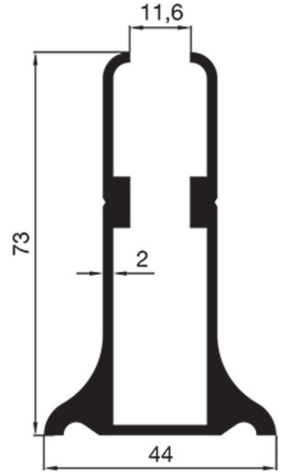

NO :94-2708  
4,420 Kg.m.

NO :94-2581  
1,420 Kg.m.

NO :94-2673  
1,240 Kg.m.

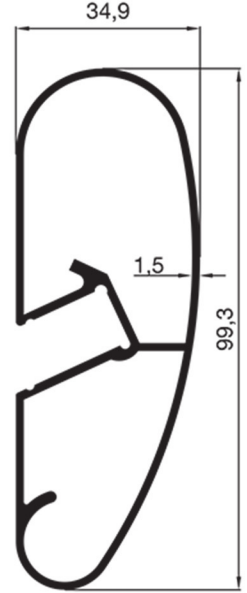
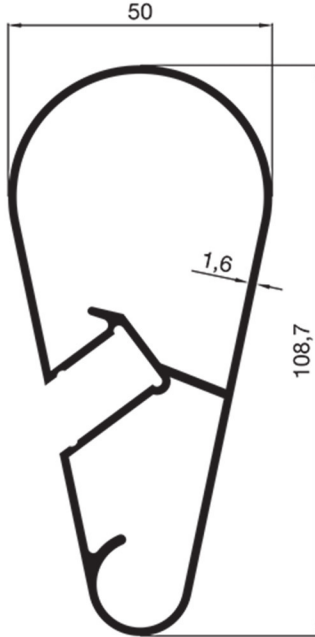
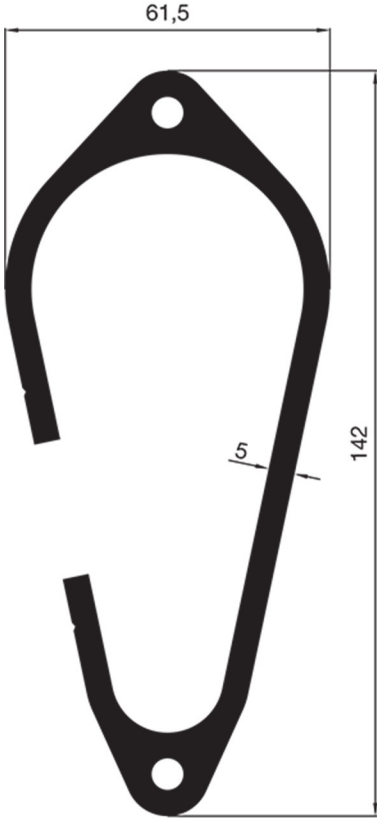

NO :94-2711  
0,635 Kg.m.

NO :94-2426  
0,530 Kg.m.

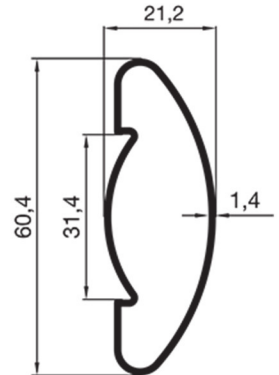
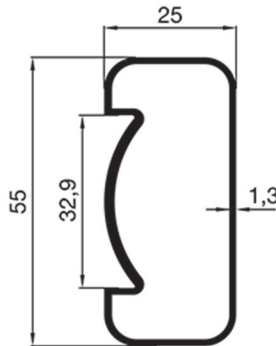

NO: 94-377

1,010 Kg.m.

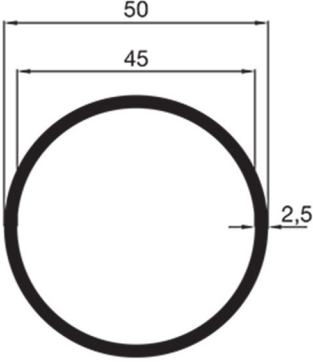

NO: 94-1154

0,810 Kg.m.

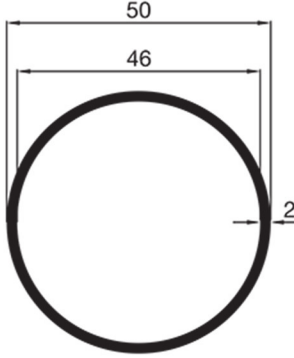

NO: 94-2524

0,740 Kg.m.

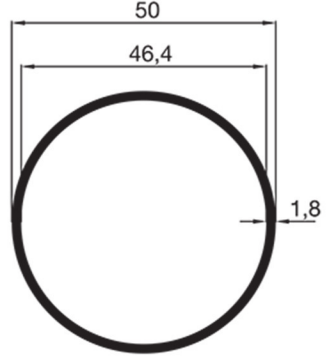

NO: 94-1949

0,620 Kg.m.

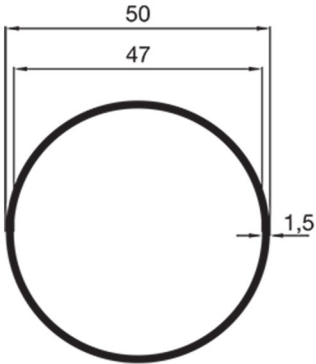

NO: 94-2437

1,000 Kg.m.

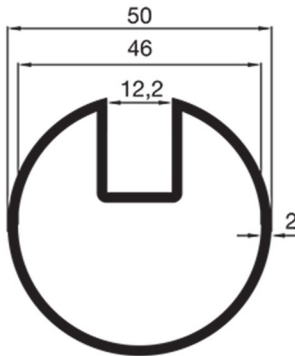

NO :94-2671

0,830 Kg.m.

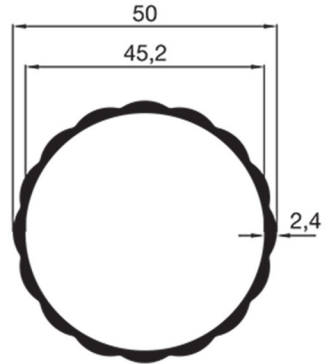

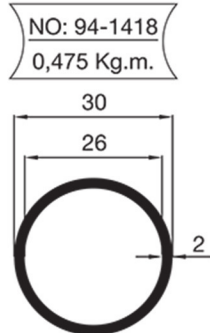
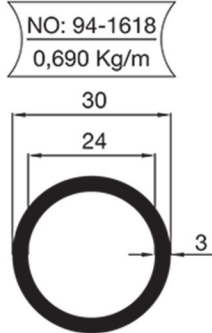
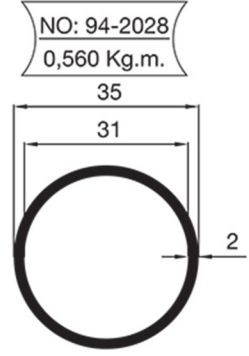
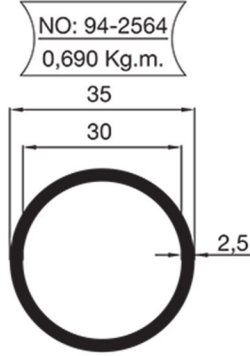
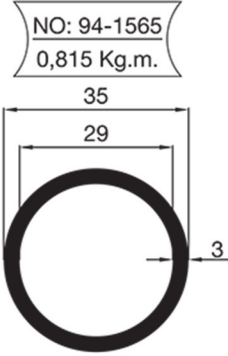
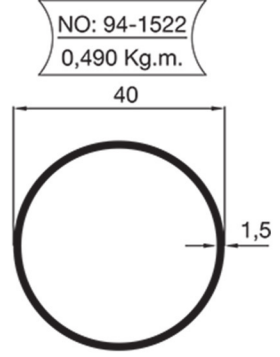
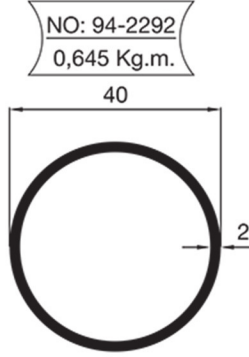
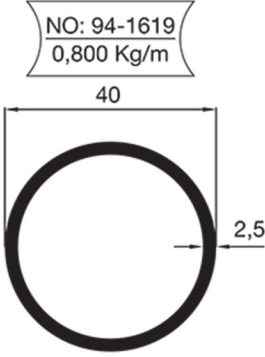



NO: 94-700  
0,350 Kg.m.

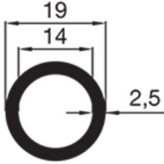

NO: 94-2267  
0,165 Kg.m.

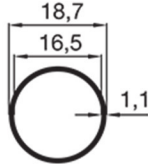

NO: 94-842  
0,155 Kg.m.

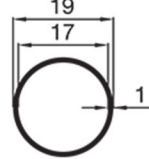

NO: 94-376  
0,470 Kg.m.

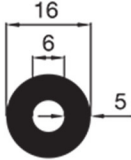

NO: 94-1785  
0,395 Kg.m.

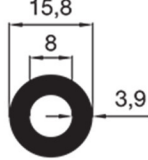

NO: 94-2286  
0,325 Kg.m.

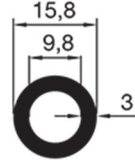

NO: 94-2670  
0,210 Kg.m.

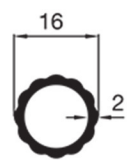

NO: 94-233  
0,240 Kg.m.

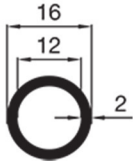

NO: 94-2565  
0,185 Kg.m.

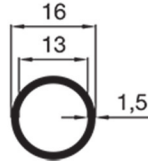

NO: 94-360  
0,130 Kg.m.

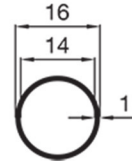

NO: 94-2049  
1,325 Kg.m.

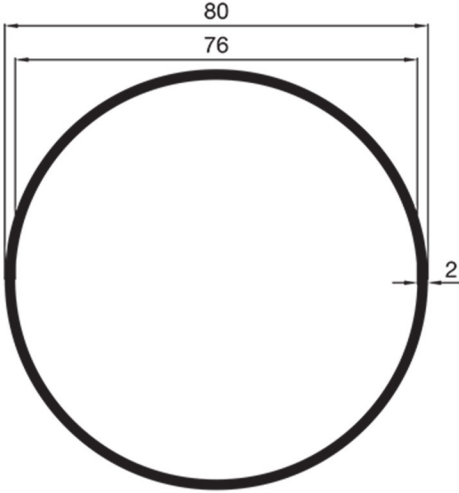

NO: 94-56  
0.870 Kg.m.

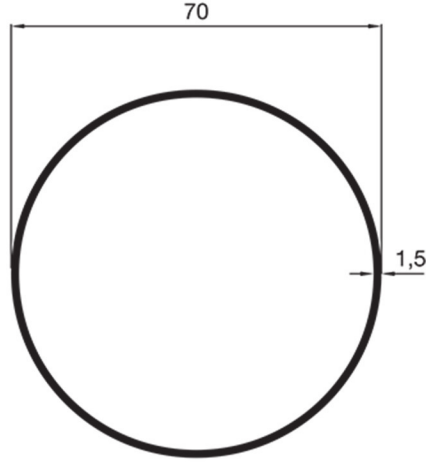

NO: 94-2304  
1,330 Kg.m.

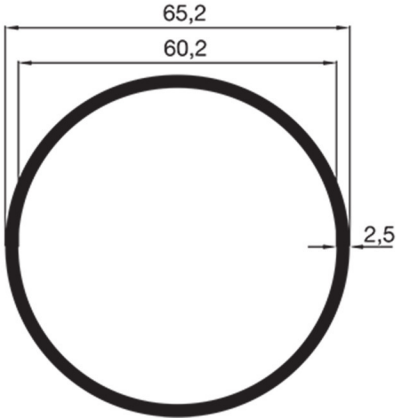

NO: 94-1246  
0,980 Kg.m.

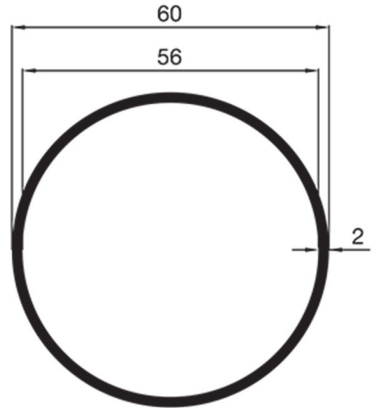

NO: 94-2241

1,685 Kg.m.

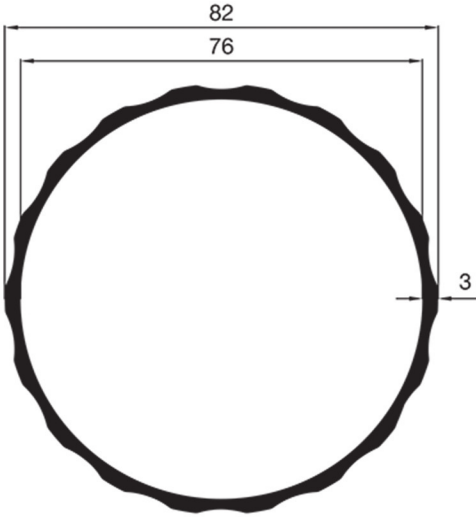

NO: 94-2439

1,410 Kg.m.

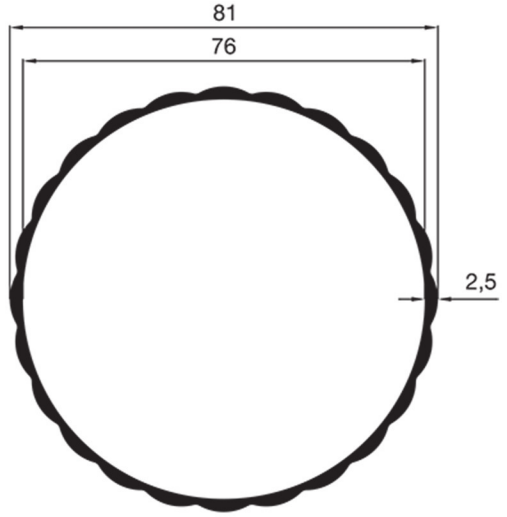

NO: 94-1816

1,370 Kg.m.

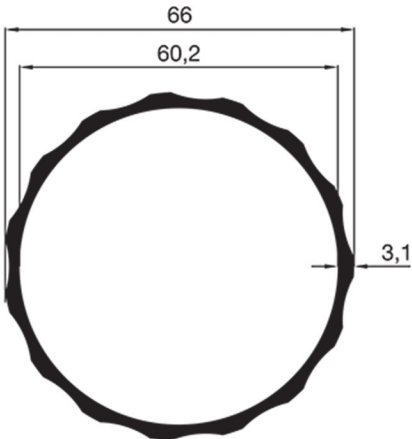

NO: 94-2438

1,100 Kg.m.

